

DEX™

A WIRELESS WORLD

COM-DEX

UK
DE
FR
ES
DK
IT
JP
US
CA

WIDEX®
HIGH DEFINITION HEARING

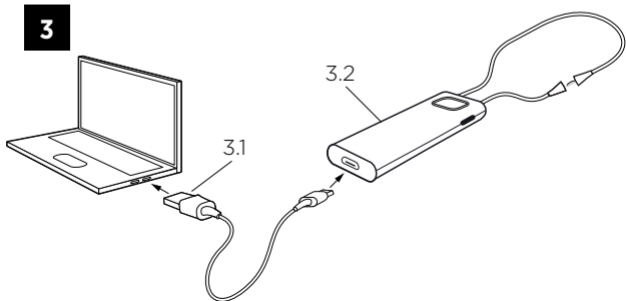
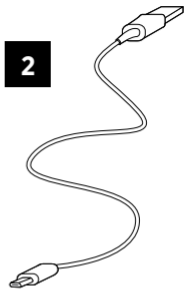
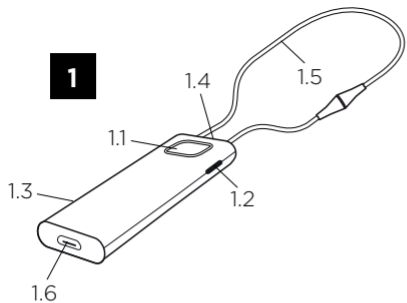

4

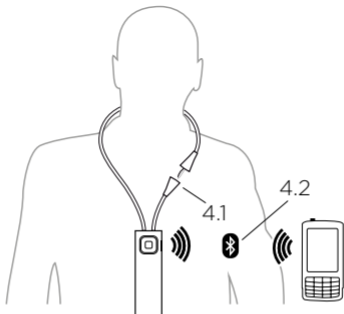

5

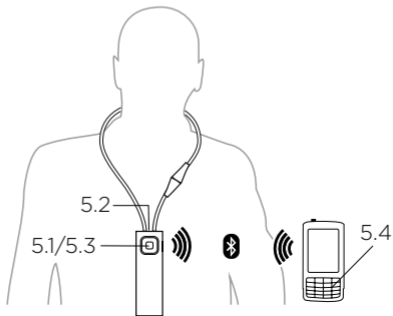

UK	USER INSTRUCTIONS.....	2
DE	BEDIENUNGSANLEITUNG.....	16
FR	MODE D'EMPLOI	30
ES	INSTRUCCIONES DE USO	44
DK	BRUGSANVISNING	58
IT	LIBRETTO D'ISTRUZIONI.....	72
JP	取扱説明書.....	86
US/CA	USER INSTRUCTIONS.....	100

DESCRIPTION OF DEVICE – *See illustration 1*

- 1.1 Push button
- 1.2 Room Off button
- 1.3 LED
- 1.4 Microphone
- 1.5 Neck loop
- 1.6 Micro USB

Note: Read these instructions carefully before you start using the device.

Intended use

The device is intended to improve the ability of hearing impaired people to conduct mobile phone conversations while using their hearing aids, to improve the usability and ease of control of such hearing aids by equipping them with a Smartphone-based control method.

Note: The device uses Bluetooth standard which is common in newer mobile phones.

ACCESSORIES – *See illustration 2*

2.1 USB cable

CHARGING – *See illustration 3*

- 3.1 Connect USB cable between the device and the power supply. We recommend that the two neck loop parts are not joined while charging the device.
- 3.2 Red light: charging, green light: fully charged.

Battery life: 8 hours streaming, 8 days standby.

HOW TO USE – *See illustration 4*

- 4.1 Join the two neck loop parts. The neck loop functions as an on/off switch.
- 4.2 Pair the device to your mobile phone using Bluetooth.

How to pair the device with your phone

To pair your device with your phone for the first time, follow these steps:

1. Make sure that the device and phone are within 1 metre range of each other.
2. Connect the neck loop. The device will blink red and blue.
3. Activate Bluetooth on your phone.
4. Start the pairing process according to the instructions in your phone's user guide.
5. Your phone will show a list of Bluetooth devices.
Select COM-DEX from the list.

Once you have paired the device, it will remain so even when you disconnect the neck loop.

Incoming calls – *See illustration 5*

- 5.1 Answer call: Press push button.
- 5.2 Speak into microphone while device is hanging around your neck.
- 5.3 End call: Press push button.

Note: Answering and ending calls is also possible on the mobile phone. Note that, on some mobile phones, you may need to select the COM-DEX from a list of devices. Otherwise the sound will be transmitted through the phone's speakers.

Outgoing calls – *See illustration 5*

- 5.4 Dial from phone.

Note: You can also use the device to stream sound from any sound source to your hearing aids.

Sound adjustment during use

Volume is adjusted on the mobile phone.

To shut out surrounding sounds: press Room Off button – See *illustration 1*.

You can download the COM-DEX app from the App Store or Google Play. This app allows you to use your phone as a remote control.

MAINTENANCE

- Clean with a damp cloth. Do not use chemicals.
- Do not expose to extreme temperatures or high humidity.
- Do not immerse in liquids.
- When the device is not in use keep it in a dry location out of reach of children and pets.
- Never try to open or repair the device yourself. This may only be done by authorised personnel.

INFORMATION ABOUT EMISSION

Emission levels from Widex devices are several times lower than the levels transmitted by mobile phones and other communications equipment.

For further information, especially regarding patients with medical implants, download the document: “Information on WidexLink™” at www.widex.com/widexlink

TROUBLESHOOTING

Problem	Possible cause	Solution
The device does not work	a) Device battery low b) The mobile phone is set to silent mode c) Hearing aid battery low d) Out of range	a) Charge device battery b) Set to normal mode c) Change hearing aid's battery d) Bluetooth has a range up to 10 m.
No sound	a) Not connected via Bluetooth	a) Repeat the pairing process

If the problems persist, contact your hearing care professional.

WARNINGS



WARNING

- Do not use the device in mines or other areas with explosive gases.
- When the device is connected via micro USB cable to external mains-operated equipment such as a charger, PC, audio source or similar, this equipment must comply with IEC 60065, IEC 60950-1, IEC 60601-1 or equivalent safety standards.







Hereby, Widex A/S declares that this COM-DEX is in compliance with the essential requirements and other relevant provisions of Directive 1999/5/EC.





A copy of the Declaration of Conformity can be found at:
<http://www.widex.com/doc>











SYMBOLS

Symbols commonly used by Widex A/S in medical device labelling (labels/IFU/etc.)

Symbol	Title/Description
	Manufacturer The product is produced by the manufacturer whose name and address are stated next to the symbol. If appropriate, the date of manufacture may also be stated.
	Date of manufacture The date when the product was manufactured.
	Use-by date The date after which the product is not to be used.
	Batch code The product's batch code (lot or batch identification).

Symbol	Title/Description
	<p>Catalogue number The product's catalogue (item) number.</p>
	<p>Serial number The product's serial number.*</p>
	<p>Keep away from sunlight The product must be protected from light sources and/or The product must be kept away from heat</p>
	<p>Keep dry The product must be protected from moisture and/or The product must be kept away from rain</p>
	<p>Lower limit of temperature The lowest temperature to which the product can be safely exposed.</p>

Symbol	Title/Description
	<p>Upper limit of temperature</p> <p>The highest temperature to which the product can be safely exposed.</p>
	<p>Temperature limits</p> <p>The highest and lowest temperatures to which the product can be safely exposed.</p>
	<p>Consult instructions for use</p> <p>The user instructions contain important cautionary information (warnings/precautions) and must be read before using the product.</p>
	<p>Caution/Warning</p> <p>Text marked with a caution/warning symbol must be read before using the product.</p>

Symbol	Title/Description
	<p>WEEE mark “Not for general waste”</p> <p>When the product is to be discarded, it must be sent to a designated collection point for recycling and recovery.</p>
	<p>CE mark</p> <p>The product is in conformity with the requirements set out in European CE marking directives.</p>
	<p>Alert</p> <p>The product is identified by R&TTE Directive 1999/5/EC as an equipment Class 2 product with some restrictions on use in some CE member states.</p>
	<p>RCM mark</p> <p>The product complies with electrical safety, EMC and radio spectrum regulatory requirements for products supplied to the Australian or New Zealand market.</p>

Symbol	Title/Description
	Interference Electromagnetic interference may occur in the vicinity of the product.

*The six- or seven-digit number on the product is the serial number. Serial numbers may not always be preceded by **SN**

GERÄTEBESCHREIBUNG – *Siehe Abbildung 1*

- 1.1 Taste
- 1.2 Taste „HG-Mikro aus“
- 1.3 LED
- 1.4 Mikrofon
- 1.5 Nackenschlaufe
- 1.6 Mikro-USB

Bitte beachten: Bitte lesen Sie diese Bedienungsanleitung aufmerksam durch, ehe Sie das Gerät in Betrieb nehmen.

Bestimmungsgemäßer Gebrauch

Dieses Gerät ist dazu vorgesehen, Personen mit Hörminderung Mobiltelefonate bei Benutzung Ihrer Hörsysteme zu ermöglichen, und gleichzeitig die Benutzbarkeit und einfache Einstellbarkeit dieser Hörsysteme mit einem Smartphone-basierenden Verfahren zu verbessern.

Bitte beachten: Das Gerät nutzt den Bluetooth-Übertragungsstandard, der bei neueren Mobiltelefonen üblich ist.

ZUBEHÖR – *Siehe Abbildung 2*

2.1 USB-Kabel

AUFLADEN – *Siehe Abbildung 3*

- 3.1 Das Gerät mit dem USB-Kabel am Netzteil anschließen. Wir empfehlen, die beiden Nackenschlaufenenden beim Laden des Geräts nicht zu verbinden.
- 3.2 Rotes Licht: lädt auf; grünes Licht: voll aufgeladen

Akkulaufzeit: 8 Stunden Dauerbetrieb / 8 Tage Standby

GEBRAUCH – *Siehe Abbildung 4*

- 4.1 Verbinden Sie die Enden der Nackenschlaufe. Die Nackenschlaufe dient auch als Ein-/Ausschalter.
- 4.2 Koppeln Sie das Gerät über Bluetooth mit Ihrem Mobiltelefon.

Das Gerät mit Ihrem Mobiltelefon koppeln

Gehen Sie bei der erstmaligen Kopplung des Gerätes mit Ihrem Mobiltelefon folgendermaßen vor:

1. Achten Sie darauf, dass das Gerät und das Mobiltelefon nicht weiter als 1 Meter voneinander entfernt sind.
2. Verbinden Sie die Enden der Nackenschlaufe. Das Gerät blinkt rot und blau.
3. Aktivieren Sie auf Ihrem Mobiltelefon Bluetooth.
4. Starten Sie die Kopplung gemäß der Bedienungsanleitung Ihres Mobiltelefons.
5. Ihr Mobiltelefon zeigt eine Liste mit Bluetooth-Geräten an. Wählen Sie COM-DEX aus der Liste.

Die Kopplung bleibt auch dann erhalten, wenn Sie die Nackenschlaufe trennen.

Eingehende Anrufe – *Siehe Abbildung 5*

- 5.1 Anruf annehmen: Drücken Sie die Taste.
- 5.2 Sprechen Sie in das Mikrofon, während Sie das Gerät um den Hals gehängt haben.
- 5.3 Anruf beenden: Drücken Sie die Taste.

Bitte beachten: Sie können Anrufe auch an Ihrem Mobiltelefon annehmen und beenden. Bitte beachten, dass Sie bei einigen Mobiltelefonen COM-DEX aus einer Geräteliste wählen müssen. Ansonsten wird der Ton über den Lautsprecher des Mobiltelefons übertragen.

Anrufe tätigen – *Siehe Abbildung 5*

- 5.4 Wählen Sie mit dem Mobiltelefon.

Bitte beachten: Sie können das Gerät auch für die Übertragung beliebiger Audioquellen zu Ihren Hörsystemen benutzen (Mono).

Lautstärkeinstellung während des Gebrauchs

Die Lautstärke wird am Mobiltelefon eingestellt.

Um Umgebungsgeräusche auszublenden, drücken Sie die Taste „HG-Mikro aus“ (Mikrofon-Stummschaltung) – *Siehe Abbildung 1.*

Sie können die COM-DEX App im App Store oder über Google Play herunterladen. Mit dieser App können Sie Ihr Mobiltelefon auch als Fernbedienung für Ihr Hörsystem nutzen.

AUFBEWAHRUNG UND ALLGEMEINE HANDHABUNG

- Zur Reinigung ein feuchtes Tuch benutzen. Keine Chemikalien verwenden.
- Setzen Sie das Gerät keinen extremen Temperaturen oder starker Feuchtigkeit aus.
- Bringen Sie das Gerät nicht mit Wasser oder anderen Flüssigkeiten in Berührung.
- Wenn Sie das Gerät nicht benutzen, bewahren Sie es an einem trockenen Ort und für Kinder und Haustiere unzugänglich auf.
- Versuchen Sie nie, das Gerät selbst zu öffnen bzw. zu reparieren, sondern bringen Sie es zu Ihrem Hörgeräte-Akustiker.

INFORMATIONEN ZU EMISSIONEN

Die Emissionswerte von Widex Geräten betragen nur ein Bruchteil der Emissionen von Mobiltelefonen und anderen Kommunikationsanlagen.

Für weitere Informationen besonders zu Patienten mit medizinischen Implantaten laden Sie bitte dieses Dokument herunter: "Informationen über WidexLink™" auf www.widex.com/widexlink

FEHLERSUCHE UND -BEHEBUNG

Problem	Mögliche Ursache	Lösung
Das Gerät funktioniert nicht	a) Geräte Akku ist fast leer b) Das Mobiltelefon ist stumm geschaltet c) Hörsystem-Batterie ist fast leer d) Gerät außer Reichweite	a) Geräte-Akku aufladen b) Normale Lautstärke einstellen c) Hörsystem-Batterie wechseln d) Bluetooth hat eine Reichweite bis zu 10 m.
Kein Ton	a) Keine Verbindung über Bluetooth	a) Kopplung wiederholen

Besteht das jeweilige Problem weiterhin, suchen Sie bitte Ihren Hörgeräte-Akustiker auf.

WARNHINWEISE



WARNUNG

- Aufgrund der einschlägigen Vorschriften darf das Gerät nicht in explosionsgefährdeten Räumen betrieben werden.
- Wenn das Gerät über ein Mikro-USB-Kabel mit einem netzbetriebenen externen Gerät (z. B. Ladegerät, PC, Audiogerät o. Ä.) verbunden wird, muss dieses Gerät die Sicherheitsvorschriften der Normen IEC 60065, IEC 60950-1, IEC 60601-1 oder vergleichbarer Normen erfüllen.







Hiermit erklärt Widex A/S, dass sich dieses COM-DEX Gerät in Übereinstimmung mit den grundlegenden Anforderungen und den anderen relevanten Vorschriften der Richtlinie 1999/5/EG befindet.

Eine Kopie der Konformitätserklärung finden Sie auf:
<http://www.widex.com/doc>







SYMBOLE



Gemeinhin von Widex A/S für die Kennzeichnung medizinischer Geräte (auf Labels, in Bedienungsanleitungen etc.) verwendete Symbole:

Symbol	Bezeichnung/Beschreibung
	Hersteller Der Name und die Adresse des Herstellers des Produktes stehen neben dem Symbol. Falls erforderlich kann auch das Herstellungsdatum angegeben sein.
	Herstellungsdatum Das Herstellungsdatum des Produktes.
	Verwendbar bis Das Datum, nach welchem das Produkt nicht mehr verwendet werden darf.
	Chargenbezeichnung Die Chargenbezeichnung des Produktes (Los- oder Chargennummer).

Symbol	Bezeichnung/Beschreibung
	<p>Bestellnummer Die Bestellnummer (Artikelnummer) des Produktes.</p>
	<p>Seriennummer Die Seriennummer des Produktes.*</p>
	<p>Vor Sonneneinstrahlung schützen Das Produkt vor Lichtquellen schützen und/oder das Produkt von Hitze fernhalten.</p>
	<p>Vor Nässe schützen Das Produkt vor Feuchtigkeit schützen und/oder das Produkt nicht dem Regen aussetzen.</p>
	<p>Untere Temperaturbegrenzung Tiefsttemperatur, der ein Produkt sicher ausgesetzt werden kann.</p>

Symbol	Bezeichnung/Beschreibung
	<p>Obere Temperaturbegrenzung Höchsttemperatur, der ein Produkt sicher ausgesetzt werden kann.</p>
	<p>Temperaturbegrenzung Temperaturgrenzwerte, denen ein Produkt sicher ausgesetzt werden kann.</p>
	<p>Bedienungsanleitung beachten Die Bedienungsanleitung enthält wichtige Warnhinweise und Informationen zu Vorsichtsmaßnahmen und muss vor Gebrauch des Produktes gelesen werden.</p>
	<p>Vorsicht/Warnung Hinweise mit diesem Symbol müssen vor Gebrauch des Produktes gelesen werden.</p>

Symbol	Bezeichnung/Beschreibung
	<p>EEAG-Kennzeichnung „Nicht im Hausmüll entsorgen.“ Das Produkt muss zu einer vorgesehenen Sammelstelle für elektronische Altgeräte gebracht und fachgerecht entsorgt werden.</p>
	<p>CE-Kennzeichnung Das Produkt befindet sich in Übereinstimmung mit den Anforderungen der europäischen Richtlinien zur CE-Kennzeichnung.</p>
	<p>Achtung Die Richtlinie 1999/5/EG (F&TEE) identifiziert dieses Produkt als ein Produkt der Geräteklasse 2 mit bestimmten Gebrauchseinschränkungen in manchen Ländern, in denen die CE-Kennzeichnung gilt.</p>

Symbol	Bezeichnung/Beschreibung
	<p>RCM Zeichen</p> <p>Das Produkt entspricht hinsichtlich der elektrischen Sicherheit, der EMV und des Funkfrequenzspektrums den regulatorischen Anforderungen an Produkte, die für den australischen und neuseeländischen Markt bestimmt sind.</p>
	<p>Interferenz</p> <p>In der Nähe des Produktes können elektromagnetische Interferenzen auftreten.</p>

* Der sechs- oder siebenstellige Code am Produkt ist die Seriennummer. Nicht in allen Fällen steht **SN** der Seriennummer voran.

DESCRIPTION DU DISPOSITIF – *Voir l'illustration 1*

- 1.1 Bouton poussoir
- 1.2 Bouton pour la coupure des microphones
- 1.3 Voyant
- 1.4 Microphone
- 1.5 Tour de cou
- 1.6 Micro USB

Remarque : Veuillez lire attentivement ce mode d'emploi avant de commencer à utiliser le dispositif.

Usage auquel ce dispositif est destiné

Ce dispositif est destiné à améliorer la capacité des personnes malentendantes à passer et recevoir des appels depuis leur téléphone portable, via leurs aides auditives. Il permet d'améliorer la fonctionnalité et le contrôle de leurs aides auditives par une application disponible pour Smartphone.

Remarque : Le dispositif utilise la norme Bluetooth, courante dans les téléphones portables récents.

LES ACCESSOIRES – *Voir l'illustration 2*

2.1 Câble USB

LE CHARGEMENT – *Voir l'illustration 3*

- 3.1 Connecter le câble USB entre le dispositif et l'alimentation électrique. Nous recommandons que les deux parties du tour de cou ne soient pas reliées pendant le chargement de l'appareil.
- 3.2 Voyant rouge : chargement, voyant vert : charge complète.

Autonomie de la pile : 8 heures de transmission / 8 jours en veille.

COMMENT L'UTILISER – *Voir l'illustration 4*

- 4.1 Relier les deux parties du tour de cou. Le tour de cou fonctionne tel un interrupteur marche/arrêt.
- 4.2 Appairez le dispositif à votre téléphone portable à l'aide du Bluetooth.

Comment appairer le dispositif à votre téléphone ?

Lorsque vous appairez le dispositif à votre téléphone pour la première fois, veuillez suivre ces étapes :

1. Assurez-vous que l'appareil et le téléphone ne sont pas éloignés de plus d'un mètre l'un de l'autre.
2. Connectez le tour de cou. Le dispositif clignotera avec une lumière rouge et bleue.
3. Activez le Bluetooth sur votre téléphone.
4. Démarrez le processus d'appairage en suivant les instructions de la notice d'utilisation de votre téléphone.
5. Votre téléphone affichera une liste d'appareils Bluetooth.
Dans la liste, sélectionnez COM-DEX.

Lorsque vous aurez appairé le dispositif, il restera ainsi même quand vous déconnecterez le tour de cou.

Appels entrants – *Voir l'illustration 5*

- 5.1 Répondre à l'appel : Appuyez sur le bouton poussoir.
- 5.2 Parlez dans le microphone lorsque le dispositif est suspendu autour de votre cou.
- 5.3 Terminer l'appel : Appuyez sur le bouton poussoir.

Remarque : Vous pouvez également prendre un appel et raccrocher sur le téléphone portable. Veuillez noter que, sur certains téléphones portables, il se peut que vous deviez sélectionner le COM-DEX dans une liste d'appareils. Sinon, le son sera transmis par les haut-parleurs du téléphone

Appels sortants – *Voir l'illustration 5*

- 5.4 Composer un numéro depuis le téléphone.

Remarque : Vous pouvez également utiliser le dispositif pour transmettre le son de n'importe quelle source sonore vers vos aides auditives.

Réglage du son pendant l'utilisation

Le volume se règle sur le téléphone portable.

Pour exclure les sons environnants : appuyez sur le bouton Coupeure des microphones – *Voir l'illustration 1.*

Vous pouvez télécharger l'application COM-DEX depuis l'App Store ou Google Play. Cette application vous permet d'utiliser votre téléphone tel une radiocommande.

L'ENTRETIEN

- Nettoyez-le avec un chiffon humide. N'utilisez pas de produits chimiques.
- Ne l'exposez pas à des températures extrêmes ou à une forte humidité.
- Ne l'immergez pas dans un liquide.
- Lorsque vous n'utilisez pas le dispositif, rangez-le dans un endroit sec, hors de portée des enfants et des animaux domestiques.
- N'essayez jamais d'ouvrir ou de réparer vous-même le dispositif. Cela doit être fait par du personnel habilité uniquement.

INFORMATIONS SUR LES ÉMISSIONS

Les niveaux d'émissions des appareils Widex sont plusieurs fois inférieurs à ceux transmis par les téléphones portables et autres équipements de communication.

Pour plus d'informations, particulièrement pour les patients avec des implants médicaux, veuillez télécharger le document :

“Information on WidexLink™” sur www.widex.com/widexlink

PROBLÈMES ET SOLUTIONS

Problème	Cause possible	Solution
L'appareil ne fonctionne pas	<ul style="list-style-type: none">a) La pile de l'appareil est épuiséeb) Le téléphone portable est en mode silencieuxc) La pile de l'aide auditive est épuiséed) Hors de portée	<ul style="list-style-type: none">a) Chargez la pile de l'appareilb) Mettez-le en mode normalc) Changez la pile de l'aide auditived) Bluetooth a une portée de 10 m.
Pas de son	<ul style="list-style-type: none">a) Pas connecté via Bluetooth	<ul style="list-style-type: none">a) Recommencez le processus d'appariement

Si les problèmes persistent, contactez votre audioprothésiste.

AVERTISSEMENTS



AVERTISSEMENTS

- N'utilisez pas le dispositif dans des mines ou d'autres lieux contenant des gaz explosifs.
- Lorsque le dispositif est connecté via un câble micro USB à du matériel alimenté sur secteur comme un chargeur, un PC, une source audio ou tout autre appareil semblable, ce matériel doit répondre aux normes CEI 60065, CEI 60950-1, CEI 60601-1 ou à toute autre norme équivalente.







Par le présent, Widex A/S déclare que ce COM-DEX est conforme aux exigences essentielles et aux autres dispositions pertinentes de la directive 1999/5/CE.





Vous trouverez une copie de la déclaration de conformité sur :
<http://www.widex.com/doc>











LES SYMBOLES

Symboles communément utilisés par Widex A/S pour l'étiquetage des dispositifs médicaux (étiquettes, instructions d'utilisation, etc.)

Symbole	Titre/Description
	Fabricant Le produit est fabriqué par le fabricant dont le nom et l'adresse sont mentionnés à côté du symbole. Le cas échéant, la date de fabrication est également mentionnée.
	Date de fabrication La date à laquelle le produit a été fabriqué.
	Date limite d'utilisation La date après laquelle le produit ne doit pas être utilisé.
	Numéro de lot Le numéro de lot du produit (identification du lot).

Symbole	Titre/Description
	<p>Référence La référence du produit.</p>
	<p>Numéro de série Le numéro de série du produit.*</p>
	<p>Ne pas exposer au rayonnement solaire Le produit doit être conservé à l'abri de la lumière et/ou le produit ne doit pas être exposé à la chaleur.</p>
	<p>Tenir au sec Le produit doit être conservé à l'abri de toute humidité et/ou le produit ne doit pas être exposé à la pluie.</p>
	<p>Température inférieure limite La température la plus basse à laquelle le produit peut être exposé sans risque.</p>

Symbole	Titre/Description
	<p>Température supérieure limite</p> <p>La température la plus élevée à laquelle le produit peut être exposé sans risque.</p>
	<p>Limites de températures</p> <p>Les températures les plus basses et les plus élevées auxquelles le produit peut être exposé sans risque.</p>
	<p>Consulter le mode d'emploi</p> <p>Le mode d'emploi comprend d'importantes informations (avertissements/précautions) qui doivent être lues avant d'utiliser le produit.</p>
	<p>Mise en garde/Avertissement</p> <p>Les textes indiqués par un symbole d'avertissement/mise en garde doivent être lus avant d'utiliser le produit.</p>

Symbole	Titre/Description
	<p>Marquage DEEE "Ne pas jeter avec les ordures ménagères ordinaires"</p> <p>Lorsque vous devez jeter le produit, il doit être envoyé dans un point de collecte officiel afin d'être recyclé et valorisé.</p>
	<p>Marquage CE</p> <p>Le produit est conforme aux exigences définies dans les directives européennes sur le marquage CE.</p>
	<p>Alerte</p> <p>Le produit est identifié par la directive RTTE 1999/5/CE comme un équipement de Classe 2 avec quelques restrictions d'utilisation dans certains pays membres de la CE.</p>
	<p>Marque RCM</p> <p>Le produit est conforme aux exigences réglementaires relatives à la CME et au spectre radioélectrique pour les produits destinés au marché australien ou néozélandais.</p>

Symbole	Titre/Description
	Interférence Il peut se produire des interférences électromagnétiques à proximité du produit.

*Les six ou sept chiffres indiqués sur le produit correspondent au numéro de série. Les numéros de série ne sont pas toujours précédés de **SN**

DESCRIPCIÓN DEL DISPOSITIVO: *vea la ilustración 1*

- 1.1 Tecla pulsadora
- 1.2 Tecla Desconexión acústica
- 1.3 LED
- 1.4 Micrófono
- 1.5 Cordón inductivo
- 1.6 Micro USB

Nota: lea atentamente estas instrucciones antes de empezar a utilizar el dispositivo.

Utilización prevista

El dispositivo ha sido desarrollado para mejorar la habilidad de las personas con pérdida auditiva de mantener conversaciones mediante teléfonos móviles mientras utilizan sus audífonos, y para mejorar el uso y el control de dichos audífonos ofreciendo al usuario un método de control por Smartphone.

Nota: el dispositivo utiliza una conexión Bluetooth estándar que es común en los teléfonos móviles más recientes.

ACCESORIOS: *vea la ilustración 2*

2.1 Cable USB

CARGA: *vea la ilustración 3*

- 3.1 Conecte el cable USB al dispositivo y al suministro de energía. Recomendamos tener desconectado el cordón inductivo mientras carga el dispositivo.
- 3.2 Diodo rojo: cargando; diodo verde: cargado.

Vida útil de la pila: 8 horas de uso/8 días en reposo.

UTILIZACIÓN: *vea la ilustración 4*

- 4.1 Conecte las dos piezas del cordón inductivo. El cordón inductivo funciona como interruptor.
- 4.2 Empareje el dispositivo a su teléfono móvil mediante Bluetooth.

Cómo emparejar el dispositivo con el móvil

Para emparejar el móvil con el dispositivo por primera vez, siga estos pasos:

1. Asegúrese de que el móvil y el dispositivo están a menos de 1 metro de distancia entre ellos.
2. Conecte el cordón inductivo. El LED del dispositivo parpadeará (luz roja y azul).
3. Active Bluetooth en su teléfono.
4. Inicie el proceso de emparejamiento siguiendo las pautas de las instrucciones de uso de su móvil.
5. Su teléfono mostrará una lista de dispositivos con Bluetooth. Seleccione COM-DEX en la lista.

Una vez emparejados el dispositivo y el móvil, ambos permanecerán emparejados aunque desconecte el cordón inductivo.

Recibir llamadas: *vea la ilustración 5*

- 5.1 Responder llamada: utilice la tecla pulsadora.
- 5.2 Hable en el micrófono del dispositivo mientras lo lleva colgado al cuello.
- 5.3 Finalizar llamada: utilice la tecla pulsadora.

Nota: también puede responder y finalizar llamadas utilizando las teclas pertinentes en su móvil. Tenga en cuenta que, con algunos móviles, deberá elegir el dispositivo COM-DEX en una lista de dispositivos. De no ser así, el sonido será transmitido a través de los altavoces del móvil.

Realizar llamadas: *vea la ilustración 5*

- 5.4 Marque el número en su móvil

Nota: también puede utilizar el dispositivo para transmitir sonido de cualquier fuente a sus audífonos.

Ajuste del sonido durante el uso

El volumen se ajusta en el teléfono móvil.

Para eliminar los sonidos del entorno: pulse la tecla Desconexión acústica, *vea la ilustración 1*.

Puede descargar la aplicación COM-DEX en App Store, o Google Play. Esta aplicación le permite utilizar el móvil como control remoto para sus audífonos.

MANTENIMIENTO

- Limpie el dispositivo con un paño húmedo. No utilice productos químicos.
- No lo exponga nunca el dispositivo a temperaturas extremas o a humedad.
- No lo sumerja en líquidos.
- Cuando no utilice el dispositivo, guárdelo en un lugar seco, fuera del alcance de los niños o animales domésticos.
- No intente nunca desmontar o reparar el dispositivo usted mismo. El dispositivo solo debe ser desmontado o reparado por personas autorizadas.

INFORMACIÓN SOBRE EMISIONES

Los niveles de emisión de los dispositivos Widex son mucho más bajos que los niveles transmitidos por los teléfonos móviles y otros equipos de comunicación.

Si desea ver más información en especial para pacientes con implantes médicos, descargue el documento: “Information on WidexLink™” at www.widex.com/widexlink

SOLUCIÓN DE PROBLEMAS

Problema	Causa posible	Solución
El dispositivo no funciona	<ul style="list-style-type: none">a) Batería del dispositivo agotadab) El móvil está en el modo silenciadoc) Pila del audífono agotadad) Fuera del radio de acción	<ul style="list-style-type: none">a) Cargue la batería del dispositivob) Ajuste el móvil al modo normalc) Cambie la pila del audífonod) Bluetooth tiene un radio de acción de hasta 10 m.
No hay sonido	<ul style="list-style-type: none">a) No hay conexión por Bluetooth	<ul style="list-style-type: none">a) Repita el proceso de emparejamiento

Si persisten los problemas, póngase en contacto con el audioprotesista.

ADVERTENCIAS



ADVERTENCIA

- No use nunca el dispositivo en minas u otras zonas con gases explosivos.
- Si conecta el dispositivo mediante un cable micro USB a un equipo externo conectado a la red de suministro, dicho equipo debe cumplir los requisitos establecidos en los estándares de seguridad IEC-60065, IEC 60950, IEC-60601-1 u otros equivalentes.







Por medio de la presente Widex A/S declara que este COM-DEX cumple con los requisitos esenciales y cualesquiera otras disposiciones aplicables o exigibles de la Directiva 1999/5/CE.





Puede ver una copia de la Declaración de conformidad en:
<http://www.widex.com/doc>









SÍMBOLOS

Éstos son los símbolos utilizados habitualmente por Widex para el etiquetado de productos sanitarios (etiquetas, instrucciones de uso, etc.)

Símbolo	Título/descripción
	Fabricante El producto ha sido producido por el fabricante cuyo nombre y dirección se indican al lado del símbolo. Si procede, también se puede indicar la fecha de fabricación.
	Fecha de fabricación La fecha de fabricación del producto.
	Fecha de caducidad La fecha tras la cual no se debe utilizar el producto.
	Número de lote El número de lote del producto (la identificación de partida o lote).

Símbolo	Título/descripción
	<p>Número de catálogo El número de catálogo del producto (artículo).</p>
	<p>Número de serie El número de serie del producto.*</p>
	<p>No exponer a la luz solar No se debe exponer el producto a fuentes de luz y/o Mantener el producto alejado de cualquier fuente de calor</p>
	<p>Mantener seco Se debe proteger el producto de la humedad y/o El producto debe ser protegido contra la lluvia</p>
	<p>Límite inferior de temperatura La temperatura más baja a la que puede ser expuesto el producto sin riesgos.</p>

Símbolo	Título/descripción
	<p>Límite superior de temperatura</p> <p>La temperatura más alta a la que puede ser expuesto el producto sin riesgos.</p>
	<p>Límites de temperatura</p> <p>Las temperaturas más altas y más bajas a las que puede ser expuesto el producto sin riesgos.</p>
	<p>Consultar las instrucciones de uso</p> <p>Las instrucciones de uso contienen información cautelar importante (avisos/precauciones) y es necesario leerlas antes de utilizar el producto.</p>
	<p>Aviso/Advertencia</p> <p>Se debe leer todo texto marcado con un símbolo de aviso/advertencia antes de usar el producto.</p>

Símbolo	Título/descripción
	<p>Marca RAEE (WEEE) "No tire el dispositivo a la basura"</p> <p>A la hora de eliminar el producto, éste debe ser enviado a un punto de recogida designado para su reciclaje y valorización.</p>
	<p>Marca CE</p> <p>El producto está en conformidad con los requisitos establecidos en las directivas europeas sobre el mercado CE.</p>
	<p>Alerta</p> <p>El producto está identificado por la Directiva R&TTE 1999/5/EC como un equipo de Clase 2, con algunas restricciones de uso aplicables en algunos Estados miembros de la UE.</p>

Símbolo	Título/descripción
	<p>Marca RCM</p> <p>El producto cumple con los requisitos reguladores de seguridad eléctrica, compatibilidad electromagnética (EMC) y de espectro de radio establecidos para los productos suministrados a los mercados de Australia y Nueva Zelanda.</p>
	<p>Interferencia</p> <p>Pueden producirse interferencias electromagnéticas en las zonas adyacentes al producto.</p>

El número de seis o siete dígitos indicado en el producto es su número de serie. El símbolo **SN** no siempre precede los números de serie

BESKRIVELSE AF ENHEDEN – *se illustration 1*

- 1.1 Trykknop
- 1.2 "HA-mik fra"-knap
- 1.3 LED
- 1.4 Mikrofon
- 1.5 Hals-slynge
- 1.6 Mikro-USB

Bemærk: Læs disse instruktioner grundigt, inden du tager enheden i brug.

Påtænkt anvendelse

Enheden er beregnet til at forbedre høreapparatbrugeres evne til at føre telefonsamtaler, mens de bruger deres høreapparat. Ved at udstyre brugerne med en smartphone-baseret kontrolmetode bliver høreapparaterne nemmere at betjene og brugervenligheden forbedres.

Bemærk: Enheden bruger Bluetooth, som findes på de fleste nyere mobiltelefoner.

TILBEHØR – *se illustration 2*

2.1 USB-kabel

OPLADNING – *se illustration 3*

- 3.1 Tilslut USB-kablet til enheden og strømforsyningen. Vi fraråder, at de to dele af halsslyngen sættes sammen, mens enheden oplades.
- 3.2 Rødt lys: oplader, grønt lys: fuldt opladet.

Batterilevetid: 8 timers streaming, 8 dages standby.

ANVENDELSE – *se illustration 4*

- 4.1 Sæt de to dele af halsslyngen sammen. Halsslyngen fungerer som tænd/sluk-kontakt.
- 4.2 Par enheden med din mobiltelefon ved hjælp af Bluetooth.

Sådan parres enheden med din telefon

Første gang, du parrer enheden med din telefon, skal du følge disse trin:

1. Sørg for, at enheden og telefonen er inden for 1 meters indbyrdes afstand.
2. Tilslut halsslyngen. Enheden blinker rødt og blå.
3. Aktiver Bluetooth på din telefon.
4. Start parringsprocessen for enheden i henhold til instruktionerne i brugsanvisningen til din telefon.
5. Din telefon viser en liste over Bluetooth-enheder.
Vælg COM-DEX fra listen.

Når du først har parret enheden, bliver den ved med at være parret, selvom du afbryder halsslyngens tilslutning.

Indgående opkald – *se illustration 5*

- 5.1 Besvar opkald: Tryk på trykknappen.
- 5.2 Tal ind i mikrofonen, mens enheden hænger om din hals.
- 5.3 Afslut opkald: Tryk på trykknappen.

Bemærk: Det er også muligt at besvare og afslutte opkald på mobiltelefonen. Bemærk, at på nogle mobiltelefoner skal du måske vælge COM-DEX fra en liste over enheder. Ellers transmitteres lyden gennem telefonens højttalere.

Udgående opkald – *se illustration 5*

- 5.4 Ring op fra telefonen.

Bemærk: Du kan også bruge enheden til at streame lyd fra alle elektroniske lyd-kilder til dine høreapparater.

Lydjustering under brug

Lydstyrken justeres på mobiltelefonen.

For at lukke lyde fra omgivelserne ude: Tryk på "HA-mik fra"-knappen – *se illustration 1.*

Du kan downloade COM-DEX appen fra App Store eller fra Google Play. Med denne app kan du bruge telefonen som fjernbetjening.

VEDLIGEHOEDElse

- Rengøres med en fugtig klud. Der må ikke bruges kemikalier.
- Må ikke udsættes for kraftig varme/kulde eller høj fugtighed.
- Må ikke lægges i væske.
- Når enheden ikke er i brug, skal den opbevares på et tørt sted, hvor børn og kæledyr ikke kan få fat i den.
- Forsøg aldrig selv at åbne eller reparere udstyret. Dette må kun udføres af autoriseret personale.

OPLYSNINGER OM EMISSION

Emissionsniveauerne fra Widex enheder er adskillige gange lavere end de niveauer, der transmitteres af mobiltelefoner og andet kommunikationsudstyr.

For at få yderligere oplysninger, der gælder specifikt for patienter med medicinske implantater, kan du downloade dokumentet: "Information om WidexLink™" fra www.widex.com/widexlink

FEJLFINDING

Problem	Mulig årsag	Løsning
Enheden virker ikke	<ul style="list-style-type: none">a) Lavt batteriniveaub) Mobiltelefonen er indstillet til lydløs tilstandc) Lavt batteriniveau i høreapparatd) Uden for rækkevidde	<ul style="list-style-type: none">a) Oplad enhedens batterib) Skift til normal tilstandc) Udskift batteriet i høreapparatetd) Bluetooth har en rækkevidde på op til 10 m.
Ingen lyd	<ul style="list-style-type: none">a) Ikke tilsluttet via Bluetooth	<ul style="list-style-type: none">a) Gentag parringsprocessen

Hvis problemet fortsætter, kontakt høreklubben.

ADVARSLER



ADVARSEL

- Brug ikke enheden i miner eller andre områder med eksplosive luftarter.
- Når enheden anvendes sammen med udstyr, som er tilsluttet via et mikro-USB-kabel, f.eks. en oplader, en PC, en lydkilde eller lignende, skal sikkerhedsreglerne for dette udstyr overholdes, som angivet i IEC 60065, IEC 60950, IEC 60601-1 eller tilsvarende standarder.







Undertegnede Widex A/S erklærer herved, at følgende udstyr COM-DEX overholder de væsentlige krav og øvrige relevante krav i direktiv 1999/5/EF.





En kopi af Overensstemmelseserklæringen kan findes under:
<http://www.widex.com/doc>





SYMBOLER



Symboler, som ofte anvendes af Widex A/S på pakkematerialet (etiketter, brugsanvisninger mv.) til medicinsk udstyr

Symbol	Titel/beskrivelse
	Producent Sammen med dette symbol angives navn og adresse på den producent, der har produceret produktet. Såfremt det er relevant, angives produktionsdatoen også.
	Produktionsdato Den dato, hvor produktet er produceret.
	Udløbsdato Produktet må ikke anvendes efter denne dato.
	Batchnummer Produktets batchnummer (identificering af batch)

Symbol	Titel/beskrivelse
	<p>Katalognummer Produktets katalognummer (varenummer)</p>
	<p>Serienummer Produktets serienummer*</p>
	<p>Produktet skal beskyttes mod sollys Produktet skal beskyttes mod lyskilder og/eller produktet skal beskyttes mod varmekilder</p>
	<p>Produktet skal holdes tørt Produktet skal beskyttes mod fugt og/eller produktet skal beskyttes mod regn</p>
	<p>Minimumtemperatur Den laveste temperatur, som produktet med sikkerhed kan tåle at blive udsat for.</p>

Symbol	Titel/beskrivelse
	<p>Maksimumtemperatur Den højeste temperatur, som produktet med sikkerhed kan tåle at blive udsat for.</p>
	<p>Temperaturforhold De højeste og laveste temperaturer, som produktet med sikkerhed kan tåle at blive udsat for.</p>
	<p>Se brugsanvisningen Brugsanvisningen indeholder vigtig sikkerhedsinformation (advarsler/forholdsregler) og skal læses, inden produktet tages i brug.</p>
	<p>Advarsel Tekst markeret med symbolet for advarsler og forholdsregler skal læses, inden produktet tages i brug.</p>

Symbol	Titel/beskrivelse
 	<p>WEEE-mærke "Må ikke kasseres som almindeligt affald"</p> <p>Når produktet skal kasseres, skal det sendes til et autoriseret indsamlingssted for genbrug og genanvendelse af elektrisk og elektronisk udstyr.</p>
	<p>CE-mærke</p> <p>Produktet overholder kravene i EU-direktiverne for CE-mærket udstyr.</p>
	<p>Bemærk</p> <p>Produktet klassificeres i henhold til R&TTE direktiv 1999/5/EF som Klasse 2 udstyr med visse anvendelsesbegrænsninger i nogle af EU- og EØS-landene.</p>

Symbol	Titel/beskrivelse
	<p>RCM-mærke</p> <p>Produktet overholder de lovgivningsmæssige krav (elektrisk sikkerhed, EMC og radiospektrum) til produkter, der leveres til det australske eller newzealandske marked.</p>
	<p>Interferens</p> <p>Elektromagnetisk interferens kan forekomme i nærheden af produktet.</p>

*Serienummeret er det 6- eller 7-cifrede nummer på produktet. Serienummeret kan være påtrykt uden foranstillet **SN**

DESCRIZIONE DEL DISPOSITIVO - *Vedere illustrazione 1*

- 1.1 Pulsante
- 1.2 Pulsante Room Off
- 1.3 LED
- 1.4 Microfono
- 1.5 Cavetto da indossare intorno al collo
- 1.6 Micro USB

Nota: vi preghiamo di leggere con molta attenzione il presente libretto d'istruzioni, prima di utilizzare questo dispositivo.

Scopo del prodotto

Questo dispositivo è stato realizzato per migliorare la capacità delle persone ipoacusiche nel comunicare con il telefono cellulare e consente un utilizzo ed una gestione più agevoli degli apparecchi acustici, grazie ad un metodo di controllo tramite smartphone.

Nota: Questo dispositivo utilizza lo standard Bluetooth, comune nei modelli di telefoni cellulari più nuovi.

ACCESSORI – *Vedere illustrazione 2*

2.1 Cavo USB

CARICAMENTO – *Vedere illustrazione 3*

- 3.1 Collegare il cavo USB tra il dispositivo e l'alimentatore per la corrente. Si raccomanda di **NON** collegare tra loro le due parti del cavetto da collo, mentre il dispositivo è in fase di caricamento.
- 3.2 Spia rossa: caricamento in corso
Spia verde: ricarica completata.

Durata della batteria: 8 ore in streaming, 8 giorni in standby.

MODALITÀ DI UTILIZZO – *Vedere illustrazione 4*

- 4.1 Collegare le due estremità del cavetto per il collo.
Il cavetto da collo funziona anche come interruttore on/off per l'accensione e lo spegnimento del dispositivo.
- 4.2 Accoppiare il dispositivo al telefono cellulare tramite il Bluetooth.

Come accoppiare il dispositivo al telefono cellulare

Per accoppiare il dispositivo al telefono cellulare per la prima volta, seguire questi passi:

1. Accertarsi che il dispositivo e il telefono si trovino entro 1 metro di distanza l'uno dall'altro.
2. Collegare il cavetto per il collo. La spia luminosa rossa e blu inizierà ora a lampeggiare.
3. Attivare il Bluetooth del cellulare.
4. Quindi, seguire la procedura di accoppiamento secondo le istruzioni del proprio telefono.
5. Sullo schermo del vostro telefono apparirà ora l'elenco dei dispositivi Bluetooth disponibili. Selezionare la voce COM-DEX dalla lista.

Una volta completata la procedura, l'accoppiamento resterà valido anche quando si scollega il cavetto da collo.

Telefonate in arrivo – *Vedere illustrazione 5*

- 5.1 Rispondere alla chiamata: premere il pulsante.
- 5.2 Quando si indossa il dispositivo intorno al collo, parlare dentro il microfono.
- 5.3 Terminare la telefonata: premere di nuovo il pulsante.

Nota: E' possibile rispondere o terminare la telefonata anche direttamente, tramite il telefono cellulare. Si fa notare che con alcuni tipi di cellulari, potrebbe prima essere necessario selezionare il COM-DEX da un elenco. Altrimenti il suono verrà trasmesso tramite l'altoparlante del telefono.

Telefonate in uscita – *Vedere illustrazione 5*

- 5.4 Comporre il numero da chiamare tramite il cellulare.

Nota: E' possibile utilizzare questo dispositivo anche per trasmettere agli apparecchi acustici il suono proveniente da qualsiasi altra sorgente sonora esterna.

Come regolare il suono durante l'uso

Il volume va regolato direttamente tramite il telefono cellulare.

Per eliminare temporaneamente i suoni ambientali:

Premere il tasto Room Off - *Vedere illustrazione 1.*

La app COM-DEX può essere scaricata da App Store oppure da Google Play. Questa app vi consente di utilizzare il telefono cellulare come fosse un telecomando.

CURA E MANUTENZIONE

- Pulire il dispositivo con un panno morbido e appena inumidito. Non usare detersivi, né altre sostanze chimiche.
- Non esporlo mai a temperature estreme o a forte umidità.
- Non immergerlo in acqua o altri liquidi.
- Quando non lo si usa, conservarlo in un luogo fresco e asciutto, fuori dalla portata di bambini ed animali.
- Non tentare mai di aprire o di riparare da soli questo dispositivo. Tali operazioni devono essere eseguite esclusivamente da personale specializzato.

INFORMAZIONI SULLE EMISSIONI

I livelli di emissioni elettromagnetiche dei dispositivi Widex sono parecchie volte più bassi di quelli emessi dai telefoni cellulari e dagli altri apparecchi per la comunicazione.

Per ulteriori informazioni, soprattutto riguardo ai pazienti con impianti medici, si prega di scaricare il documento: "Informazioni su WidexLink™" da questo link: www.widex.com/widexlink

SOLUZIONI RAPIDE AI PROBLEMI

Problema	Possibile causa	Soluzione
Il dispositivo non funziona	<ul style="list-style-type: none">a) Batteria scaricab) Il cellulare è impostato in modalità silenziosac) Batteria dell'apparecchio acustico quasi esauritad) Fuori campo operativo	<ul style="list-style-type: none">a) Caricare la batteria del dispositivob) Impostarlo in modalità normalec) Sostituire la batteria dell'apparecchio acusticod) Il campo operativo del Bluetooth arriva fino a 10 mt
mtNessun suono	<ul style="list-style-type: none">a) Non connesso tramite Bluetooth	<ul style="list-style-type: none">a) Ripetere la procedura di accoppiamento

Se il problema persiste, contattare il proprio Audioprotesista.

AVVERTENZE IMPORTANTI



ATTENZIONE

- Questo dispositivo non è omologato per l'utilizzo nelle miniere o in altre zone con gas esplosivi e dunque, in simili circostanze, non deve essere usato.
- Quando si collega il dispositivo tramite il cavo micro USB ad apparecchiature esterne alimentate da corrente elettrica quali caricatore, computer, riproduttori audio o simili, è necessario accertarsi che tali apparecchiature siano conformi alle direttive IEC 60065, IEC 60950, IEC 60601-1 ed alle norme di sicurezza equivalenti.



Con la presente Widex A/S dichiara che il presente dispositivo COM-DEX è conforme ai requisiti essenziali ed alle altre disposizioni pertinenti stabilite dalla Direttiva 1999/5/CE.

Una copia della Dichiarazione di Conformità
può essere consultata su:





<http://www.widex.com/doc>











N26346



SIMBOLI

Simboli utilizzati solitamente da Widex A/S per l'etichettatura dei suoi dispositivi medici (etichette, IFU, informazioni di prodotto ecc.)

Simbolo	Titolo/Descrizione
	Produttore Il prodotto è stato fabbricato dalla casa produttrice, il cui nome ed indirizzo appaiono accanto a questo simbolo. Quando necessario, viene riportata anche la data di fabbricazione.
	Data di fabbricazione La data in cui il prodotto è stato fabbricato.
	Scadenza La data oltre la quale non bisogna più utilizzare il prodotto.
	Codice del lotto Il codice che identifica il lotto del prodotto (identificazione lotto).

Simbolo	Titolo/Descrizione
	<p>Codice catalogo</p> <p>Il codice numerico che identifica il prodotto all'interno del catalogo.</p>
	<p>Numero seriale</p> <p>Il numero di serie del prodotto.*</p>
	<p>Tenere al riparo dalla luce del sole</p> <p>Il prodotto deve essere protetto dalle sorgenti luminose e/o deve essere mantenuto al riparo dal calore.</p>
	<p>Tenere all'asciutto</p> <p>Il prodotto deve essere protetto dall'umidità e/o deve essere tenuto al riparo dalla pioggia.</p>
	<p>Limite minimo di temperatura</p> <p>Questa è la temperatura minima che il prodotto è in grado di sopportare senza rischi.</p>

Simbolo	Titolo/Descrizione
	<p>Limite massimo di temperatura</p> <p>Questa è la temperatura massima che il prodotto è in grado di sopportare senza rischi.</p>
	<p>Limiti di temperatura</p> <p>Questi sono i limiti di temperatura massima e minima che il prodotto è in grado di sopportare senza rischi.</p>
	<p>Consultare le istruzioni per l'uso</p> <p>Le istruzioni per l'uso contengono informazioni importanti per gli utenti (avvertenze e precauzioni) e devono essere lette con attenzione prima di utilizzare il prodotto.</p>
	<p>Precauzioni/Avvertenze</p> <p>Il testo contrassegnato da questo simbolo contiene delle avvertenze e precauzioni importanti e deve essere letto con attenzione prima di utilizzare il prodotto.</p>

Simbolo	Titolo/Descrizione
	<p>Marchio RAEE Questo prodotto elettronico va smaltito come rifiuto speciale, non generico.</p> <p>Quando si decide di eliminare il prodotto è necessario inviarlo agli appositi punti di raccolta, per il riciclo ed il recupero dei materiali.</p>
	<p>Marchio CE</p> <p>Il prodotto è conforme alle prescrizioni imposte dalle Direttive Europee CE.</p>
	<p>Avviso</p> <p>Il prodotto è identificato dalla Direttiva 1999/5/CE R&TTE come apparecchiatura di Classe 2, avente delle limitazioni per l'utilizzo in alcuni Stati membri CE.</p>

Simbolo	Titolo/Descrizione
	<p>Marchio RCM</p> <p>Questo prodotto è conforme alle normative riguardanti la sicurezza elettrica, le emissioni elettromagnetiche e radio in vigore in Australia e Nuova Zelanda.</p>
	<p>Interferenza</p> <p>In prossimità del prodotto potrebbero verificarsi delle interferenze elettromagnetiche.</p>

*Il numero a sei o sette cifre presente sul prodotto è il numero di serie. I numeri seriali non sempre sono preceduti da **SN**

機器の概要 – 図1. を参照

- 1.1 プッシュ ボタン
- 1.2 補聴器マイクオフ ボタン
- 1.3 LED
- 1.4 マイク
- 1.5 ネックループ
- 1.6 マイクロ USB

注意: 本器をご使用になる前にこの取扱説明書をお読みください。

使用目的

補聴器を使って携帯電話での通話をしやすくすること、スマートフォンにより補聴器の操作を簡易にすること

注意: 多くのスマートフォンに搭載されている Bluetooth (ブルートゥース) 機能を使用します。

付属品 – 図2. 参照

2.1 USB ケーブル

充電方法 – 図3. 参照

3.1 USB ケーブルで本器と電源を接続します。充電する際、ネックループの接続部を外すことを推奨します。

3.2 赤点灯：充電中、緑点灯：充電完了

連続使用時間：伝送時8時間、待機時8日間

使用方法 – 図4. 参照

4.1 ネックループを接続します。

ネックループはオン・オフスイッチを兼ねています。

4.2 本器とスマートフォンをBluetoothペアリングします。

ペアリングの方法

初めてペアリングするときには、以下の手順で行います：

1. 本器とスマートフォンの距離が1m以内であるようにします。
2. ネックループを接続します。赤色と青色の点滅が始まります。
3. スマートフォンのBluetoothを有効にします。
4. スマートフォンの取扱説明書に従い、ペアリングを開始します。
5. 表示されるBluetooth デバイスリストから COM-DEX を選択します。

一度ペアリングされると、ネックループを切断してもペアリングは有効です。

電話の着信 – 図5. 参照

- 5.1 通話開始: プッシュボタンを押します。
- 5.2 本器を首からぶら下げ、内蔵マイクに話します。
- 5.3 通話終了: プッシュボタンを押します。

注意: 通話の開始・終了は、スマートフォンの操作でも可能です。場合によっては、通話音声出力可能な機器リストからCOM-DEXを選択する必要があります。COM-DEXが選択されていないとスマートフォンのスピーカーから通話音声が出力されます。

電話の発信 – 図5. 参照

- 5.4 スマートフォンで番号をダイヤルします。

参考: 本器を使って、様々な音響機器の音信号を補聴器へ伝送することができます。

使用中の音量調節

スマートフォン上で音量を調節します。

周囲の音を防ぐ：補聴器マイクオフボタンを押します。-

図1. 参照

COM-DEXアプリをApp Store や Google Playからダウンロードできます。このアプリを使うことでスマートフォンから補聴器をリモコン操作できます。

お手入れ

- ・ お手入れの際は、乾いたやわらかい布で拭いてください。決して水や洗剤などを使用しないでください。
- ・ 高温、高湿度の場所は避けてください。
- ・ 水やその他の液体に浸さないでください。
- ・ 使用しない時はケースに保管し、お子さまやペットの手の届かない、涼しい、湿度の低い場所で保管してください。
- ・ 絶対にご自分で分解、または修理しようとししないでください（許可された人によってのみ行われます）。

電磁放射に関して

本器から放射される電磁波のレベルは、スマートフォンや他の通信機器に比べて格段に低くなっています。

埋め込み型の医療機器をご使用する場合の情報“Information on WidexLink™”(英文)につきましては、下記リンクよりダウンロード可能です。

“<http://www.widex.com/widexlink>”

故障と思われるときの対処法

問題	考えられる要因	解決策
動作しない	a) 電池容量の低下 b) スマートフォンがサイレント（無音）モードになっている c) 補聴器の電池容量の低下 d) 通信範囲外	a) 充電します b) 通常モードに設定します c) 補聴器の電池を交換します d) 通信範囲内に近づけます （Bluetooth通信範囲10m）
音が聞こえない	a) Bluetoothで接続されていない	a) 再度ペアリングします

それでも問題が改善しない場合は、販売店にご相談ください。

特に注意すること



- ・ 本器を鉱山、爆発性ガスのある場所で使用しないでください。
- ・ 充電器、パソコン、音源などの電源コンセントにつないだ外部機器にマイクロUSBケーブルを通して本器を接続する場合、その外部機器が国際規格IEC 60065、IEC 60950-1、IEC 60601-1、または同等の安全基準に準拠していることが求められます。



Widex A/S 社は、COM-DEX が指令1995/5/ECの基本的要求事項および関連事項に適合することを宣言します。





適合宣言のコピーは、下記にてご覧いただけます。





<http://www.widex.com/doc>





取扱説明書で使用される記号

ワイデックス株式会社が製造販売する管理医療機器の表示
(ラベル/取扱説明書/等)に共通して使用される記号

記号	名称/意味
	製造元 製品の製造者名、製造所の所在地 製造年月も記載される場合があります。
	製造年月 製品が製造された年月
	使用期限年月 製品の使用可能期限
	ロット番号 製品のロット番号（製造時の生産単位を特定する番号）

記号	名称/意味
	<p>カタログ番号 製品のカタログ (品目) 番号</p>
	<p>シリアル番号 製品のシリアル (製造)番号*</p>
	<p>直射日光、熱遮蔽 製品を、直射日光および熱から遮蔽してください。</p>
	<p>水ぬれ禁止 製品を湿気から護り、雨に濡らさないでください。</p>
	<p>保管温度の下限 製品を安全に保管できる最低温度</p>

記号	名称/意味
	<p>保管温度の上限 製品を安全に保管できる最高温度</p>
	<p>保管温度限界 製品を安全に保管できる最高および最低温度</p>
	<p>取扱説明書を参照 取扱説明書には安全に関する重要なお知らせ (重要/注意) が含まれていますので、製品のご使用前に必ずお読みください。</p>
	<p>重要/注意 重要/危険注意の記号を伴う事項は、製品のご使用前に必ずお読みください。</p>
	<p>WEEEマーク 一般廃棄物ではありません。 製品の廃棄は、自治体により定められた分別回収・リサイクルに従ってください。</p>

記号	名称/意味
	<p>CEマーク 製品は、CEマークに関する欧州指令によって定められた要件に適合しています。</p>
	<p>注意 製品は、R&TTE指令（無線機器、電気通信端末機器に関する欧州指令）により、一部CE加盟国での使用に制限を伴うクラス2機器として分類されます。</p>
	<p>RCM マーク 製品は、オーストラリアとニュージーランド市場に供給される製品に対する、電气的安全性およびEMC・無線スペクトル規制要件に準拠しています。</p>

記号	名称/意味
	電磁波による干渉 製品の近くでは電磁波による干渉が起きる可能性があります。

*製品に記載されている6桁または7桁の数字はシリアル番号です。製品によっては、シリアル番号の前に**SN**が記載されない場合もあります。

DESCRIPTION OF DEVICE – *See illustration 1*

- 1.1 Push button
- 1.2 Room Off button
- 1.3 LED
- 1.4 Microphone
- 1.5 Neck loop
- 1.6 Micro USB

Note: Read these instructions carefully before you start using the device.

Intended use:

This device is intended to improve your ability to use Bluetooth enabled mobile phone connections with your hearing aid(s). The aid(s) can further be manipulated by the controls on the mobile phone.

Note: The device uses Bluetooth standard which is common in newer mobile phones.

ACCESSORIES – *See illustration 2*

2.1 USB cable

CHARGING – *See illustration 3*

- 3.1 Connect USB cable between the device and any power supply. We recommend that the two neck loop parts are not joined while charging the device.
- 3.2 Red light: charging, green light: fully charged.

Battery life: 8 hours streaming, 8 days standby.

HOW TO USE – *See illustration 4*

- 4.1 Join the two neck loop parts. The neck loop functions as an on/off switch.
- 4.2 Pair the device to your mobile phone using Bluetooth.

How to pair the device with your mobile phone

To pair your device with your mobile phone for the first time, follow these steps:

1. Make sure that the device and mobile phone are within 3 ft range of each other.
2. Connect the neck loop. The device will blink red and blue.
3. Activate Bluetooth on your mobile phone.
4. Start the pairing process according to the instructions in your mobile phone's user guide.
5. Your mobile phone will show a list of Bluetooth devices. Select COM-DEX from the list.

Once you have paired the device, it will remain paired even when you disconnect the neck loop.

Incoming calls – *See illustration 5*

- 5.1 Answer call: Press push button.
- 5.2 Speak into microphone while device is hanging around your neck.
- 5.3 End call: Press push button.

Note: Answering and ending calls is also possible on the mobile phone. Note that, on some mobile phones, you may need to select the COM-DEX from a list of devices. Otherwise the sound will be transmitted through the mobile phone's speakers.

Outgoing calls – *See illustration 5*

- 5.4 Dial from mobile phone.

Note: You can also use the device to stream sound from any Bluetooth enabled sound source to your hearing aids.

Sound adjustment during use

Volume is adjusted on the mobile phone.

To shut out surrounding sounds: press Room Off button – See *illustration 1*.

You can download the COM-DEX app from the App Store or Google Play. This app allows you to use your mobile phone as a remote control.

MAINTENANCE

- Clean with a damp cloth. Do not use chemicals.
- Do not expose to extreme temperatures or high humidity.
- Do not immerse in liquids.
- When the device is not in use keep it in a dry location out of reach of children and pets.
- Never try to open or repair the device yourself. This may only be done by authorized personnel.

INFORMATION ABOUT EMISSION

Emission levels from Widex devices are several times lower than the levels transmitted by mobile phones and other communications equipment.

For further information, especially regarding patients with medical implants, download the document: “Information on WidexLink™” at www.widex.com/widexlink

TROUBLESHOOTING

Problem	Possible cause	Solution
The device does not work	a) Device battery low b) The mobile phone is set to silent mode c) Hearing aid battery low d) Out of range	a) Charge device battery b) Set to normal mode c) Change hearing aid battery d) Bluetooth has a range up to 30 ft.
No sound	a) Not connected via Bluetooth	a) Repeat the pairing process

If the problems persist, contact your hearing care professional.

WARNINGS



WARNING

- Do not use the device in mines or other areas with explosive gases.
- When the device is connected via micro USB cable to external mains-operated equipment such as a charger, PC, audio source or similar, this equipment must comply with IEC 60065, IEC 60950-1, IEC 60601-1 or equivalent safety standards.

REGULATORY INFORMATION

The following Table summarizes the technical details of the Bluetooth and WidexLink technology as it is implemented in the COM-DEX.

Unit	COM-DEX		Hearing aid
Type	W-link	Bluetooth*	W-link
Antenna type	Inductive Loop antenna	Embedded ceramic antenna	Inductive antenna
Antenna dimensions	L: 70 cm	NA	Ø1.8 mm L – 4.85mm
Modulation	FSK	FHSS/GFSK, $\pi/4$ DPSK, 8DPSK	FSK

Magnetic Field Strength	-26dB μ A/m at 10m distance	NA	-54dB μ A/m at 10m distance
Output power	1.2 nW EIRP** -59 dBm	2.5 mW EIRP +4dBm	29pW EIRP** -75 dBm
Range	<1m remote unit to hearing aid	<10m between COM-DEX and Bluetooth device	<1m remote unit to hearing aid <30cm between hearing aids
Center frequency	10.6MHz	2.45GHz ISM	10.6MHz
Channels	Single channel radio	80 channels	Single channel radio

Bandwidth	660kHz (-15dB)	1MHz	660kHz (-15dB)
Duty Cycle ***	Up to 100 %	< 100 %	< 5 %
Data rate	212kbit/s raw channel capac- ity	3 Mbit/s	212kbit/s raw channel capac- ity
Data flow	Simplex or semiduplex	Time division duplex (TDD)	Simplex or semiduplex
Protocol	Random access - no collision avoidance	Packet based protocol, time divided	Random access - no collision avoidance

** Bluetooth specification v 4.1 + EDR/LE published by the Bluetooth Special Interest Group (SIG)*

*** EIRP = Equivalent isotropically radiated power*

**** Duty Cycle averaged over 1 hour of operation*



Cables and transducers:

The COM-DEX is using a micro USB cable for charging.

Guidance and manufacturer's declaration

Electromagnetic emissions

The COM-DEX is intended for use in the electromagnetic environment specified below. The customer or the user of a COM-DEX should assure that it is used in such an environment.

Emissions test	Compliance	Electromagnetic environment - guidance
RF emissions CISPR 11	Group 1	The COM-DEX uses RF energy only for its internal function. Therefore, its RF emissions are very low and are not likely to cause any interference in nearby electronic equipment.

RF emissions CISPR 11	Class B	The COM-DEX is suitable for use in all establishments, including domestic establishments and those directly connected to the public low-voltage power supply network that supplies buildings used for domestic purposes.
Harmonic emissions IEC 61000-3-2	Not applicable *)	
Voltage fluctuations/ flicker emissions IEC 61000-3-3	Not applicable *)	

*) *Battery powered equipment*

Electromagnetic immunity

The COM-DEX is intended for use in the electromagnetic environment specified below. The customer or the user of a COM-DEX should assure that it is used in such an environment.

Immunity Test	IEC 60601 Test level	Compliance level	Electromagnetic environment – guidance
Electro-static discharge (ESD) IEC 61000-4-2	± 6 kV contact ± 8 kV air	± 6 kV contact ± 8 kV air	Floors should be wood, concrete or ceramic tile. If floors are covered with synthetic material, the relative humidity should be at least 30 %.

<p>Electrical fast transients/ burst IEC 61000-4-4</p>	<p>± 2 kV for power line supplies ± 1 kV for input/output lines</p>	<p>Not applicable *) Not applicable *)</p>	<p>Not applicable *)</p>
<p>Surge IEC 61000-4-5</p>	<p>± 1 kV line(s) to line(s) ± 2 kV line(s) to earth</p>	<p>Not applicable *) Not applicable *)</p>	<p>Not applicable *)</p>

<p>Voltage dips, short interruptions and voltage variations on power supply input lines IEC 61000-4-11</p>	<p><5 % U_T (>95 % dip in U_T) for 0.5 cycle</p> <p>40 % U_T (60 % dip in U_T) for 5 cycles</p> <p>70 % U_T (30 % dip in U_T) for 25 cycles</p> <p><5 % U_T (>95 % dip in U_T) for 5 s</p>	<p>Not applicable *)</p>	<p>Not applicable *)</p>
----------------------------------------------------------------------------------------------------------------	--------------------------------------------------------------------------------------------------------------------------------------------------------------------------------------------------------------------------------------------------------------------------------------------------------------------------------	--------------------------	--------------------------

Power frequency (50/60 Hz) magnetic field IEC 61000-4-8	3 A/m	3 A/m	Power frequency magnetic fields should be at levels characteristic of a typical location in a typical commercial or hospital environment
---------------------------------------------------------------	-------	-------	------------------------------------------------------------------------------------------------------------------------------------------

NOTE U_T is the a.c. mains voltage prior to the application of the test level.

**) Battery powered equipment*

Electromagnetic immunity – cont.

The COM-DEX is intended for use in the electromagnetic environment specified below. The customer or the user of a COM-DEX should assure that it is used in such an environment.

Immunity Test	IEC 60601 Test level	Compliance level	Electromagnetic environment – guidance
			Portable and mobile RF communications equipment should be used no closer to any part of the COM-DEX, including cables, than the recommended separation distance calculated from the equation applicable to the frequency of the transmitter.

Conducted RF	3 Vrms	3 Vrms	Recommended separation distance $d = 1.2 \sqrt{P}$
IEC 61000-4-6	150 kHz to 80 MHz		
Radiated RF	3 V/m	3 V/m	$d = 1.2 \sqrt{P}$ 80 MHz to 800 MHz
IEC 61000-4-3	80 MHz to 2.5 GHz		$d = 2.3 \sqrt{P}$ 800 MHz to 2.5 GHz

Where P is the maximum output power rating of the transmitter in watts (W) according to the transmitter manufacturer and d is the recommended separation distance in metres (m).

Field strengths from fixed RF transmitters, as determined by an electromagnetic site survey^a, should be less than the compliance level in each frequency range^b.

Interference may occur in the vicinity of equipment marked with the following symbol:



NOTE 1 At 80 MHz and 800 MHz, the higher frequency range applies

NOTE 2 These guidelines may not apply in all situations. Electromagnetic propagation is affected by absorption and reflection from structures, objects and people.

a. Field strengths from fixed transmitters, such as base stations for radio (cellular/cordless) telephones and land mobile radios, amateur radio, AM and FM radio broadcast and TV broadcast cannot be predicted theoretically with accuracy. To assess the electromagnetic environment due to fixed RF transmitters, an electromagnetic site survey should be considered. If the measured field strength in the location in which the COM-DEX is used exceeds the applicable RF compliance level above, the COM-DEX should be observed to verify normal operation. If abnormal performance is observed, additional measures may be necessary, such as re-orienting or re-locating the COM-DEX.

b. Over the frequency range 150 kHz to 80 MHz, field strengths should be less than 3 V/m.

Recommended separation distances

Recommended separation distances between portable and mobile RF communication equipment and the COM-DEX.

The COM-DEX is intended for use in the electromagnetic environment in which RF disturbances are controlled. The customer or the user of the COM-DEX can help prevent electromagnetic interference by maintaining a minimum distance between portable and mobile RF communications equipment (transmitters) and the COM-DEX as recommended below, according to the maximum output power of the communications equipment.

Rated maximum output power of transmitter W	Separation distance according to frequency of transmitter m		
	150 kHz to 80 MHz $d = 1.2 \sqrt{P}$	80 MHz to 800 MHz $d = 1.2 \sqrt{P}$	800 MHz to 2.5 GHz $d = 2.3 \sqrt{P}$
0.01	0.12	0.12	0.23
0.1	0.38	0.38	0.73

1	1.2	1.2	2.3
10	3.8	3.8	7.3
100	12	12	23

For transmitters rated at a maximum output power not listed above, the recommended separation distance d in metres (m) can be estimated using the equation applicable to the frequency of the transmitter, where P is the maximum output power rating of the transmitter in watts (W) according to the transmitter manufacturer.

NOTE 1 At 80 MHz and 800 MHz, the higher frequency range applies

NOTE 2 These guidelines may not apply in all situations. Electromagnetic propagation is affected by absorption and reflection from structures, objects and people.

This COM-DEX may be interfered with by other equipment even if that other equipment complies with CISPR emission requirements.

EMC/EMI Compliance

The COM-DEX complies with the following EMC/EMI standards:

Standard	Test type	Note
47 CFR Part 15, subpart C	RF emissions	USA Federal Communications Commission (FCC) requirements to intentional radiators.
EN 300 330-2 V1.6.1	RF emissions incl. Spurious emission	EMC and radio spectrum matters for Short Range Devices in the frequency range 9 kHz – 25 MHz
EN 300 328 V1.9.1	RF emissions incl. Spurious emission	EMC and radio spectrum matters for data transmission systems in the 2.4 GHz ISM band and using wide band modulation techniques
IEC 60601-1-2:2007	EMC emission Immunity, RF and ESD	Medical electrical equipment. General requirements for basic safety and essential performance. Electromagnetic compatibility.

EN 301 489-3 V1.6.1	Immunity, RF and ESD	Standard for Low Power Transmitters in the frequency range 9 kHz – 40 GHz
EN 301 489-17 V2.2.1	Immunity, RF and ESD	Standard for Broadband Data Trans- mission Systems in the frequency range 9 kHz – 40 GHz







Hereby, Widex A/S declares that this COM-DEX is in compliance with the essential requirements and other relevant provisions of Directive 1999/5/EC.





A copy of the Declaration of Conformity can be found at:
<http://www.widex.com/doc>











SYMBOLS

Symbols commonly used by Widex A/S in medical device labeling (labels/IFU/etc.)

Symbol	Title/Description
	Manufacturer The product is produced by the manufacturer whose name and address are stated next to the symbol. If appropriate, the date of manufacture may also be stated.
	Date of manufacture The date when the product was manufactured.
	Use-by date The date after which the product is not to be used.
	Batch code The product's batch code (lot or batch identification).

Symbol	Title/Description
	<p>Catalog number The product's catalog (item) number.</p>
	<p>Serial number The product's serial number.*</p>
	<p>Keep away from sunlight This product must be protected from light source and must be kept away from heat.</p>
	<p>Keep dry The product must be protected from moisture and/or The product must be kept away from rain.</p>
	<p>Lower limit of temperature The lowest temperature to which the product can be safely exposed.</p>

Symbol	Title/Description
	Upper limit of temperature The highest temperature to which the product can be safely exposed.
	Temperature limits The highest and lowest temperatures to which the product can be safely exposed.
	Consult instructions for use The user instructions contain important cautionary information (warnings/precautions) and must be read before using the product.
	Caution/Warning Text marked with a caution/warning symbol must be read before using the product.

Symbol	Title/Description
	<p>WEEE mark “Not for general waste”</p> <p>When the product is to be discarded, it must be sent to a designated collection point for recycling and recovery.</p>
	<p>CE mark</p> <p>The product is in conformity with the requirements set out in European CE marking directives.</p>
	<p>Alert</p> <p>The product is identified by R&TTE Directive 1999/5/EC as an equipment Class 2 product with some restrictions on use in some CE member states.</p>
	<p>RCM mark</p> <p>The product complies with EMC and radio spectrum regulatory requirements for products supplied to the Australian or New Zealand market.</p>

Symbol	Title/Description
	Interference Electromagnetic interference may occur in the vicinity of the product.

*The six- or seven-digit number on the product is the serial number. Serial numbers may not always be preceded by **SN**

FCC AND IC STATEMENTS

FCC ID: TTY-CMDEX

IC: 5676B-CMDEX

Federal Communications Commission Statement

This device complies with part 15 of the FCC Rules. Operation is subject to the following two conditions:

- (1) This device may not cause harmful interference, and
- (2) this device must accept any interference received, including interference that may cause undesired operation.

NOTE:

This equipment has been tested and found to comply with the limits for a Class B digital device, pursuant to part 15 of the FCC Rules. These limits are designed to provide reasonable protection against harmful interference in a residential installation. This equipment generates, uses and can radiate radio frequency energy and, if not installed and used in accordance with the instructions, may cause harmful interference to radio communications. However, there is no guarantee that interference will not occur in a particular installation. If this equipment does cause harmful interference to radio or television reception, which can be determined by turning the

equipment off and on, the user is encouraged to try to correct the interference by one or more of the following measures:

- Reorient or relocate the receiving antenna.
- Increase the separation between the equipment and receiver.
- Connect the equipment into an outlet on a circuit different from that to which the receiver is connected.
- Consult the dealer or an experienced radio/TV technician for help.

NOTE:

This equipment complies with FCC radiation exposure limits set forth for an uncontrolled environment. This transmitter must not be co-located or operating in conjunction with any other antenna or transmitter.

Changes or modifications to the equipment not expressly approved by Widex could void the user's authority to operate the equipment.

Industry Canada Statement / Déclaration d'industrie Canada

Under Industry Canada regulations, this radio transmitter may only operate using an antenna of a type and maximum (or lesser) gain approved for the transmitter by Industry Canada.

To reduce potential radio interference to other users, the antenna type and its gain should be so chosen that the equivalent isotropically radiated power (e.i.r.p.) is not more than that necessary for successful communication.

This device complies with Industry Canada licence-exempt RSS standard(s). Operation is subject to the following two conditions:

- (1) this device may not cause interference, and
- (2) this device must accept any interference, including interference that may cause undesired operation of the device.

Conformément à la réglementation d'Industrie Canada, le présent émetteur radio peut fonctionner avec une antenne d'un type et d'un gain maximal (ou inférieur) approuvé pour l'émetteur par Industrie Canada.

Dans le but de réduire les risques de brouillage radioélectrique à l'intention des autres utilisateurs, il faut choisir le type d'antenne et son gain de sorte que la puissance isotrope rayonnée équivalente (p.i.r.e.) ne dépasse pas l'intensité nécessaire à l'établissement d'une communication satisfaisante.

Le présent appareil est conforme aux CNR d'Industrie Canada applicables aux appareils radio exempts de licence. L'exploitation est autorisée aux deux conditions suivantes :

- (1) l'appareil ne doit pas produire de brouillage, et
- (2) l'utilisateur de l'appareil doit accepter tout brouillage radioélectrique subi, même si le brouillage est susceptible d'en compromettre le fonctionnement.



WIDEX A/S

Nymoellevej 6, DK-3540 Lyngby, Denmark
www.widex.com



Manual no.:
9 514 0313 080 #02
Issue:
2015-09



9 514031 308000